

Dielectric Chip Antenna 1561~1610MHz
Part No: MP11524

Model: DCA70S01
Rev. No: 2

1. SCOPE:

This specification covers the GPS+GNSS+BEIDOU.

2. NAME OF THE PRODUCT:

This product is named “Dielectric Chip Antenna”.

3. ELECTRICAL CHARACTERISTICS:

3.1. Electrical characteristics of antenna

The antenna has the electrical characteristics given in Table 1 under the *cirocomm* standard installation conditions shown in the figure of Evaluation Board.

Table 1

No	Parameter	Specification
1	Working Frequency	1561~1610MHz
2	Dimension	3.05×1.6×0.55mm
3	VSWR	2.0
4	Polarization	Linear
5	Impedance	50Ω
6	Operating Temperature	-40~85°C

*Data is measured on Cirocomm STD PCB.

Dielectric Chip Antenna 1561~1610MHz
Part No: MP11524

Model: DCA70S01
Rev. No: 2

4. ANTENNA:

4.1. Antenna Dimension

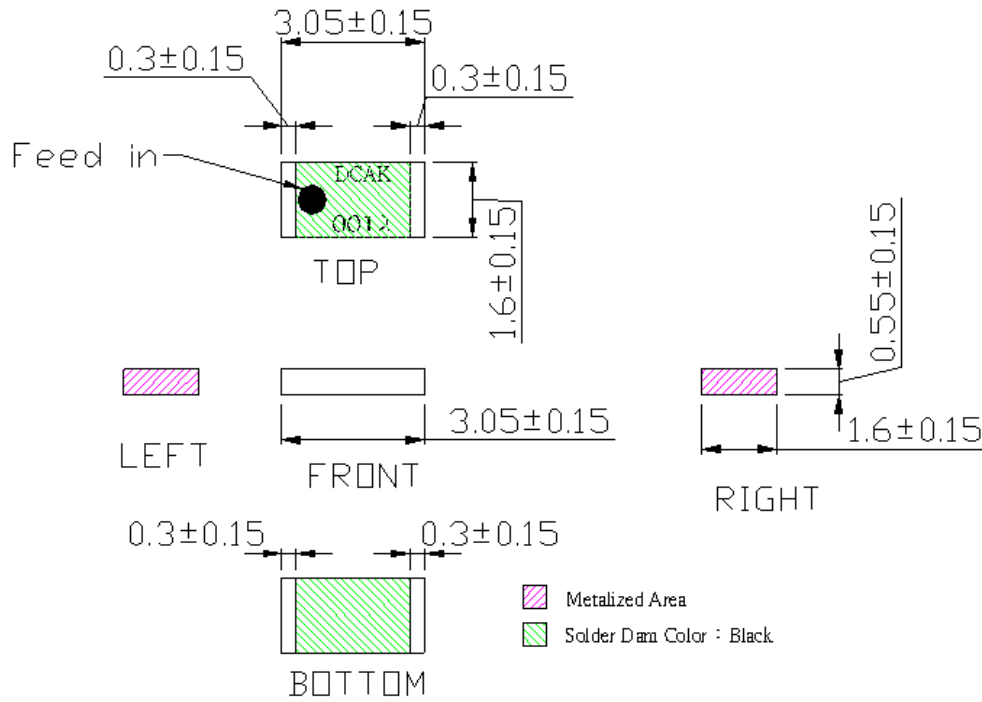

Unit: mm

4.2. Demo Board Dimension

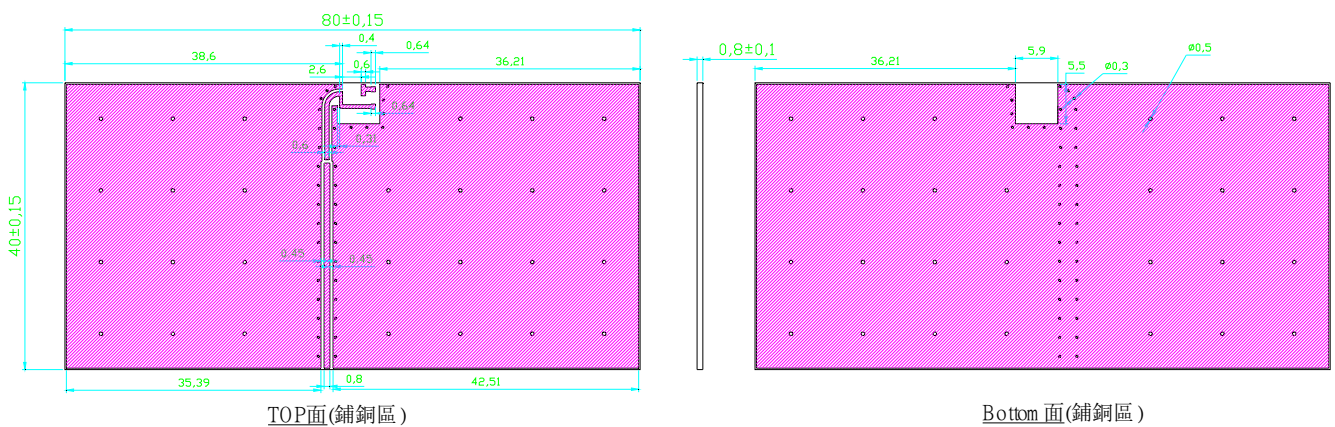

Dielectric Chip Antenna 1561~1610MHz
Part No: MP11524

Model: DCA70S01
Rev. No: 2

4.3. Recommend Layout dimension

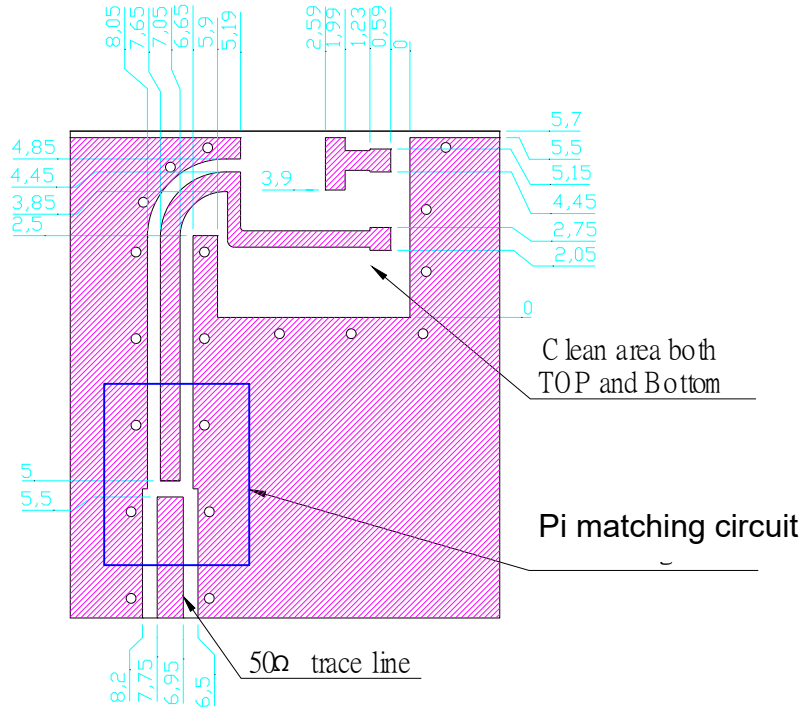

4.4. Matching Circuit

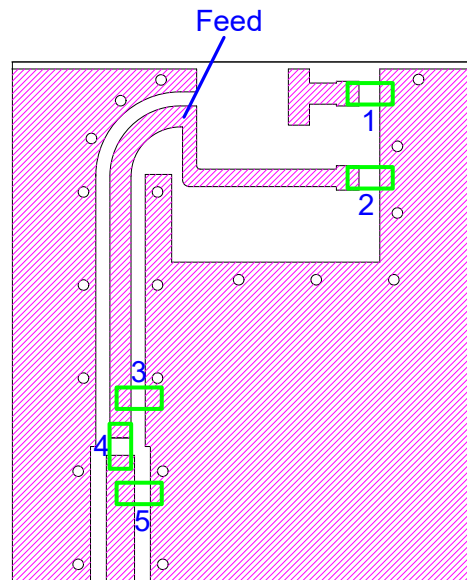

Matching Circuit Component					
NO.	1	2	3	4	5
Description	2pF	1pF	3.3pF	0 ohm	N.F.

Dielectric Chip Antenna 1561~1610MHz
Part No: MP11524

Model: DCA70S01
Rev. No: 2

4.5. Return Loss

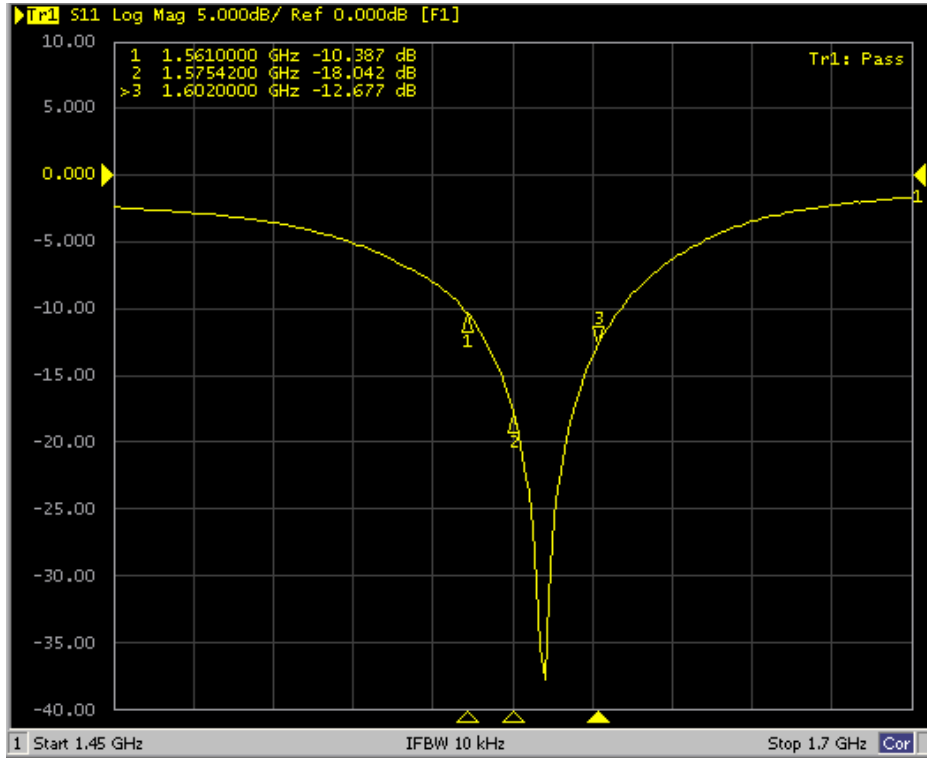

Frequency(MHz)	1561	1575.42	1602
S11(dB)	-10.38	-18.04	-12.67

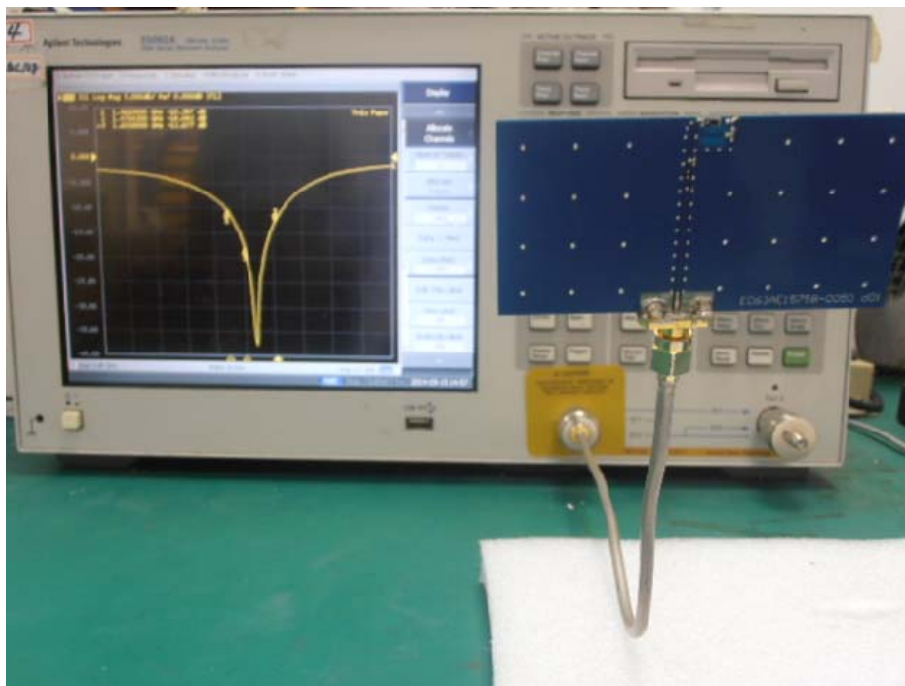

Dielectric Chip Antenna 1561~1610MHz
Part No: MP11524

Model: DCA70S01
Rev. No: 2

4.6. 2D Radiation Pattern

1561MHz

XZ

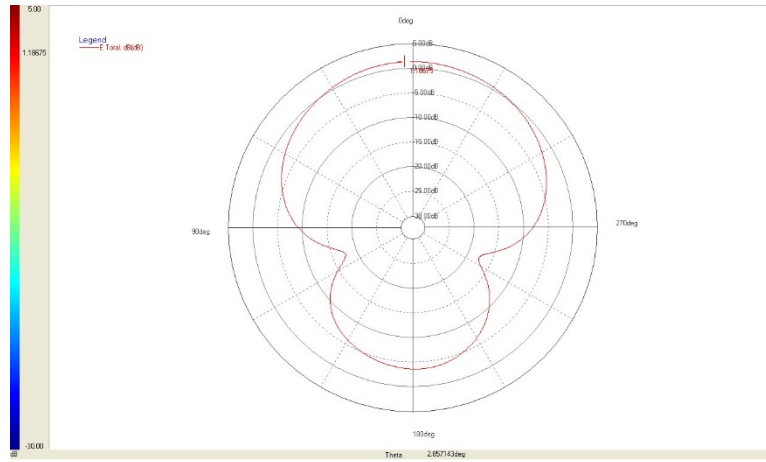

YZ

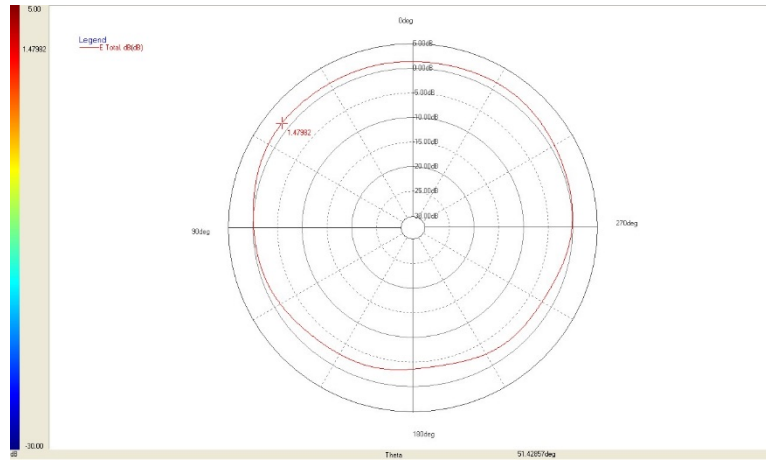

XY

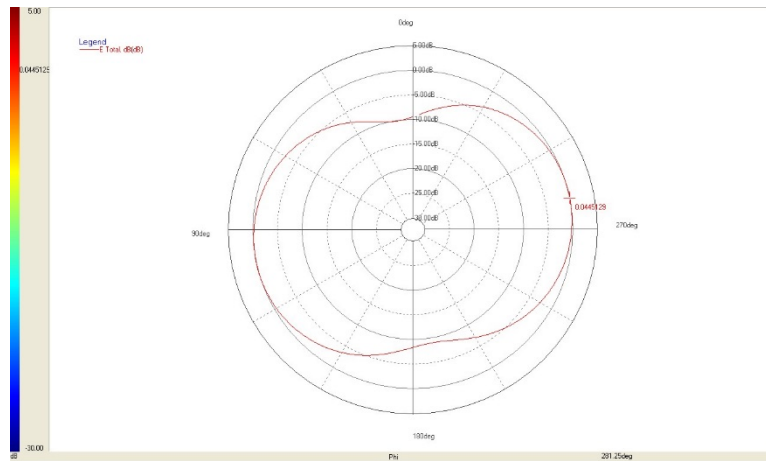

Dielectric Chip Antenna 1561~1610MHz
Part No: MP11524

Model: DCA70S01
Rev. No: 2

1575.42MHz

XZ

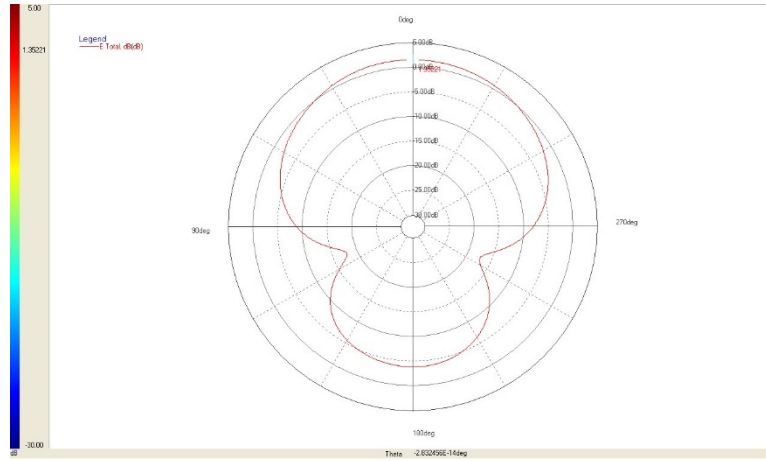

YZ

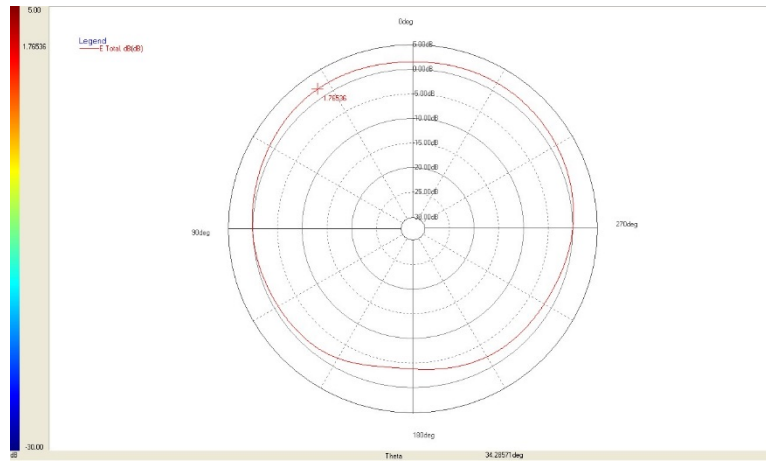

XY

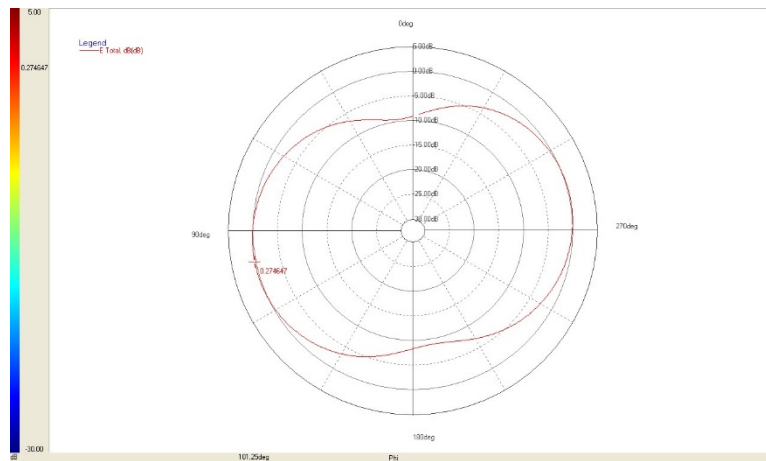

Dielectric Chip Antenna 1561~1610MHz
Part No: MP11524

Model: DCA70S01
Rev. No: 2

1602MHz

XZ

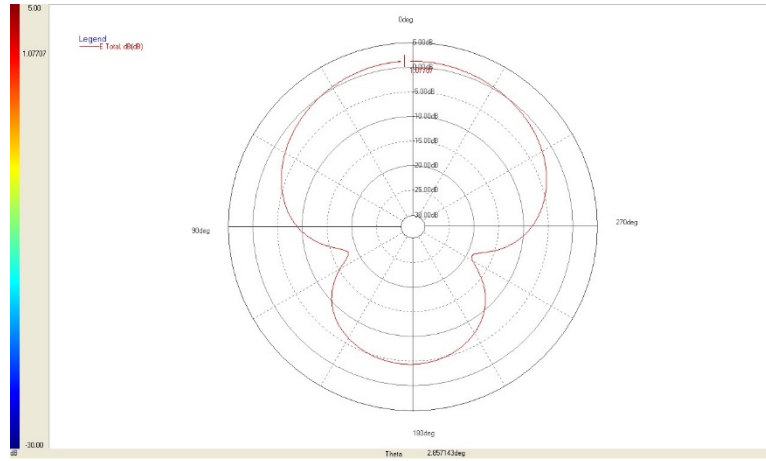

YZ

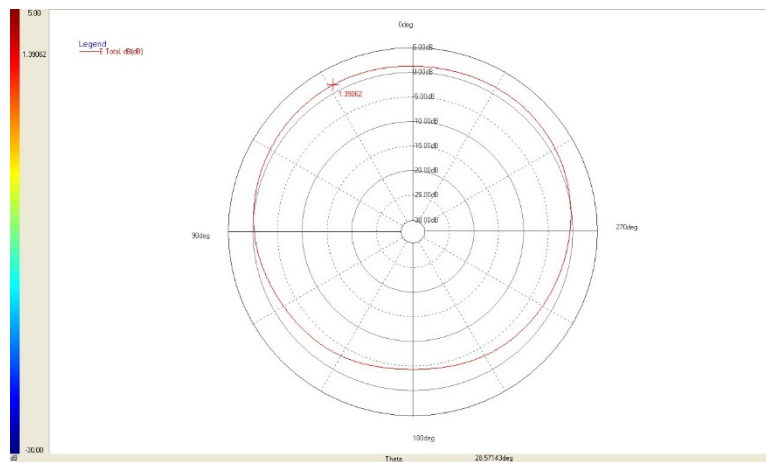

XY

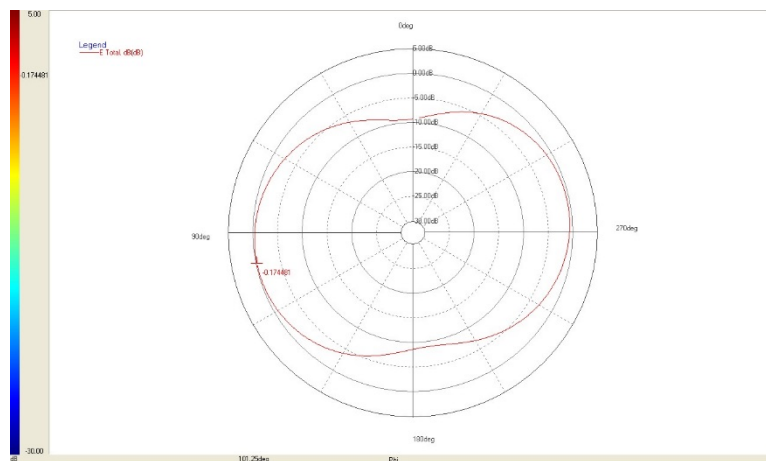

Dielectric Chip Antenna 1561~1610MHz
Part No: MP11524

Model: DCA70S01
Rev. No: 2

4.7. Efficiency



4.8. Average Gain

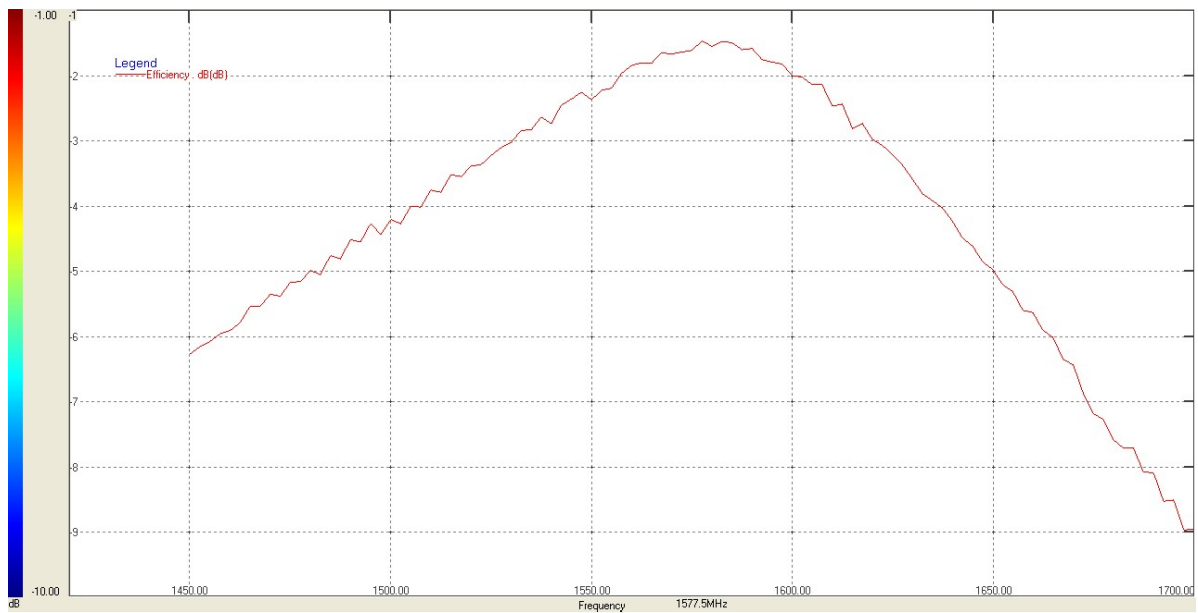

Dielectric Chip Antenna 1561~1610MHz
Part No: MP11524

Model: DCA70S01
Rev. No: 2

4.9. Peak Gain

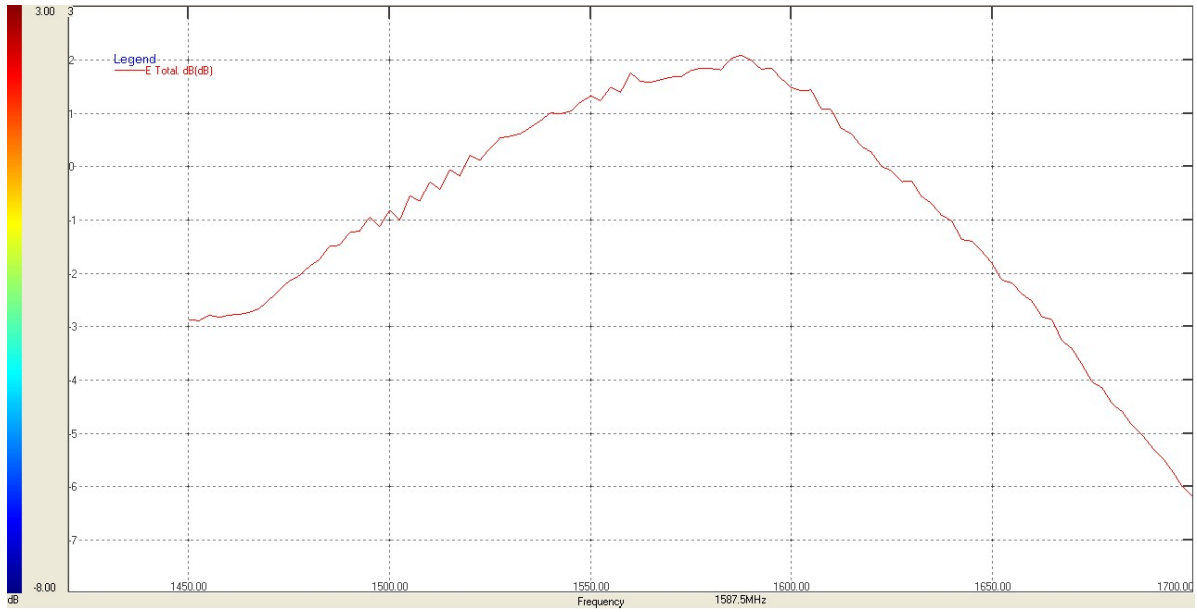

Frequency(MHz)	1561	1575.42	1602
Efficiency(%)	65.74	70.06	63.27
Average Gain(dBi)	-1.82	-1.54	-1.98
Peak Gain(dBi)	1.69	1.81	1.43

Dielectric Chip Antenna 1561~1610MHz
Part No: MP11524

Model: DCA70S01
Rev. No: 2

4.10. 3D Radiation Pattern

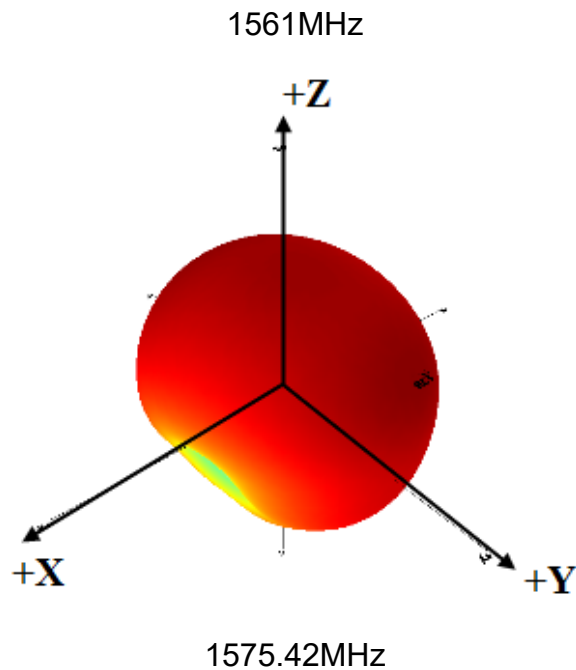
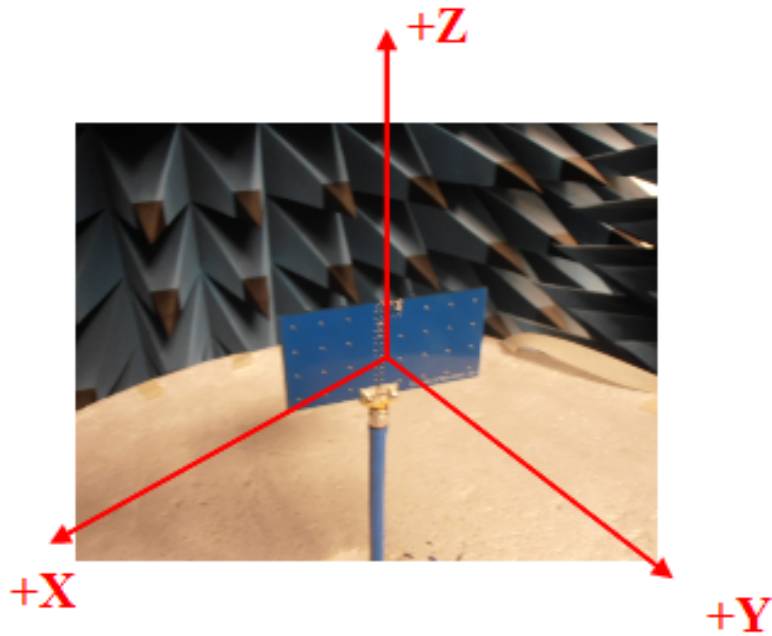

Dielectric Chip Antenna 1561~1610MHz
Part No: MP11524

Model: DCA70S01
Rev. No: 2

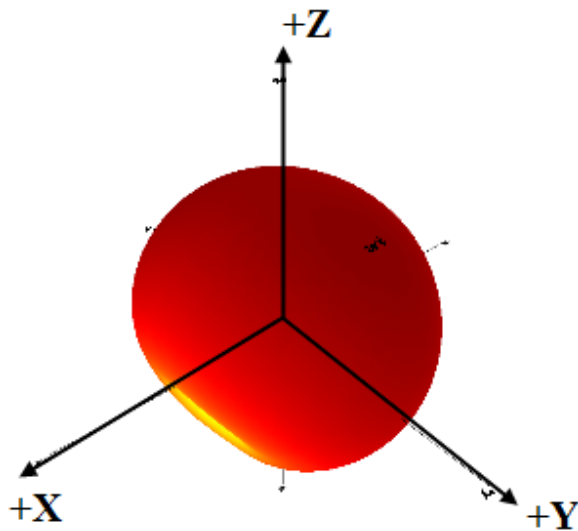
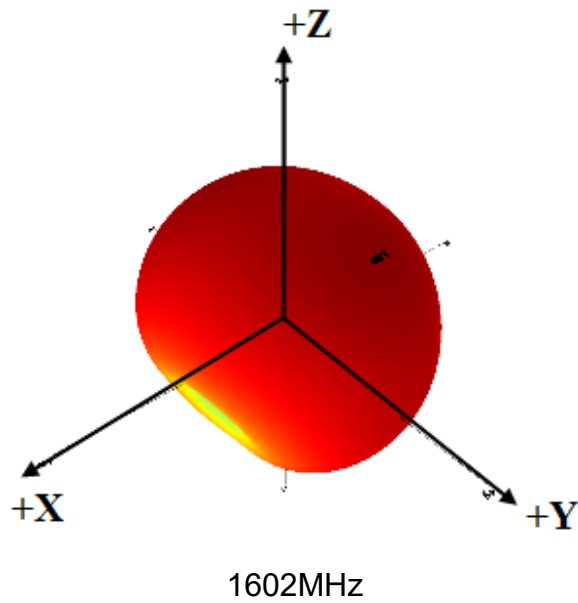

Dielectric Chip Antenna 1561~1610MHz
Part No: MP11524

Model: DCA70S01
Rev. No: 2

5. ENVIRONMENTAL CONDITIONS:

5.1 Operating conditions

The antenna has the electrical characteristics given in Tables 1 in the temperature range of -40°C to +85°C and under the environmental conditions of +40°C and 0-95% relative humidity.

5.2 Storage temperature range

The storage temperature range of product is -40°C to +85°C.

6. RELIABILITY TESTS:

6.1 Low-temperature test

Expose the specimen to -40°C for 16 hours and then to normal temperature/humidity for 24 hours or more. After this test, examine its appearance and functions.

6.2 High-temperature test

Expose the specimen to +85°C for 16 hours and then to normal temperature/humidity for 24 hours or more. After this test, examine its appearance and functions.

6.3 High-temperature/high-humidity test

Subject the object to the environmental conditions of +85°C and 90-95% relative humidity for 96 hours, then expose it to normal temperature/humidity for 24 hours or more. After this test, examine its appearance and functions.

6.4 Thermal shock test

Subject the object to cyclic temperature change (-40°C, 30 minutes ⇔ +85°C, 30 minutes) for 5 cycles, then expose to normal temperature/ humidity for 24 hours or more.

Dielectric Chip Antenna 1561~1610MHz
Part No: MP11524

Model: DCA70S01
Rev. No: 2

6.5. Vibration test

6.5.1. Sinusoidal vibration test

Subject the object to vibrations of 5 to 200 to 5Hz swept in 10 minutes, 4.5G at maximum (2mm amplitude), in X and Y directions for two hours each and in Z direction for four hours. After this test, examine its appearance functions.

6.5.2. Vibration test in packaged condition

Subject the object, which is packaged as illustrated, to vibrations of 15 to 60 to 15Hz swept in 6 minutes, 4G at maximum (2mm amplitude at maximum), applied in X, Y and Z directions for two hours each, i.e. six hours in total. After this test, examine its appearance and functions.

6.6. Free fall test in packaged condition

Drop the object, which is packaged as illustrated, to a concrete surface from the height of 90 cm, on one corner, three edges and six faces once each, i.e. 10 times in total. After this test, examine its appearance and functions.

6.7. Soldering heat resistance test

The lead pins of the unit are soaked in solder bath at $260 \pm 5^{\circ}\text{C}$ for 10 seconds. After this test, examine its appearance and functions.

6.8. Adhesion test

The device is subjected to be soldered on test PCB. Then apply 0.5Kg (5N) of force for 5 ± 1 seconds in the direction of parallel to the substrate. (The soldering should be done by reflow and be conducted with care so that the soldering is uniform and free of defect by stress such as heat shock).

Dielectric Chip Antenna 1561~1610MHz
Part No: MP11524

Model: DCA70S01
Rev. No: 2

7. WARRANTY:

If any defect occurs from the product during proper use within a year after delivery, it will be repaired or replaced free of charge.

8. OTHER:

Any question arising from this specification manual shall be solved by arrangement made by both parties.

Dielectric Chip Antenna 1561~1610MHz
Part No: MP11524

Model: DCA70S01
Rev. No: 2

9. DELIVERY MODE:

1. Blister tape to IEC 286-3,polyester.
2. Pieces/tape:5000 pcs.
3. Moisture sensitivity level: Level 1

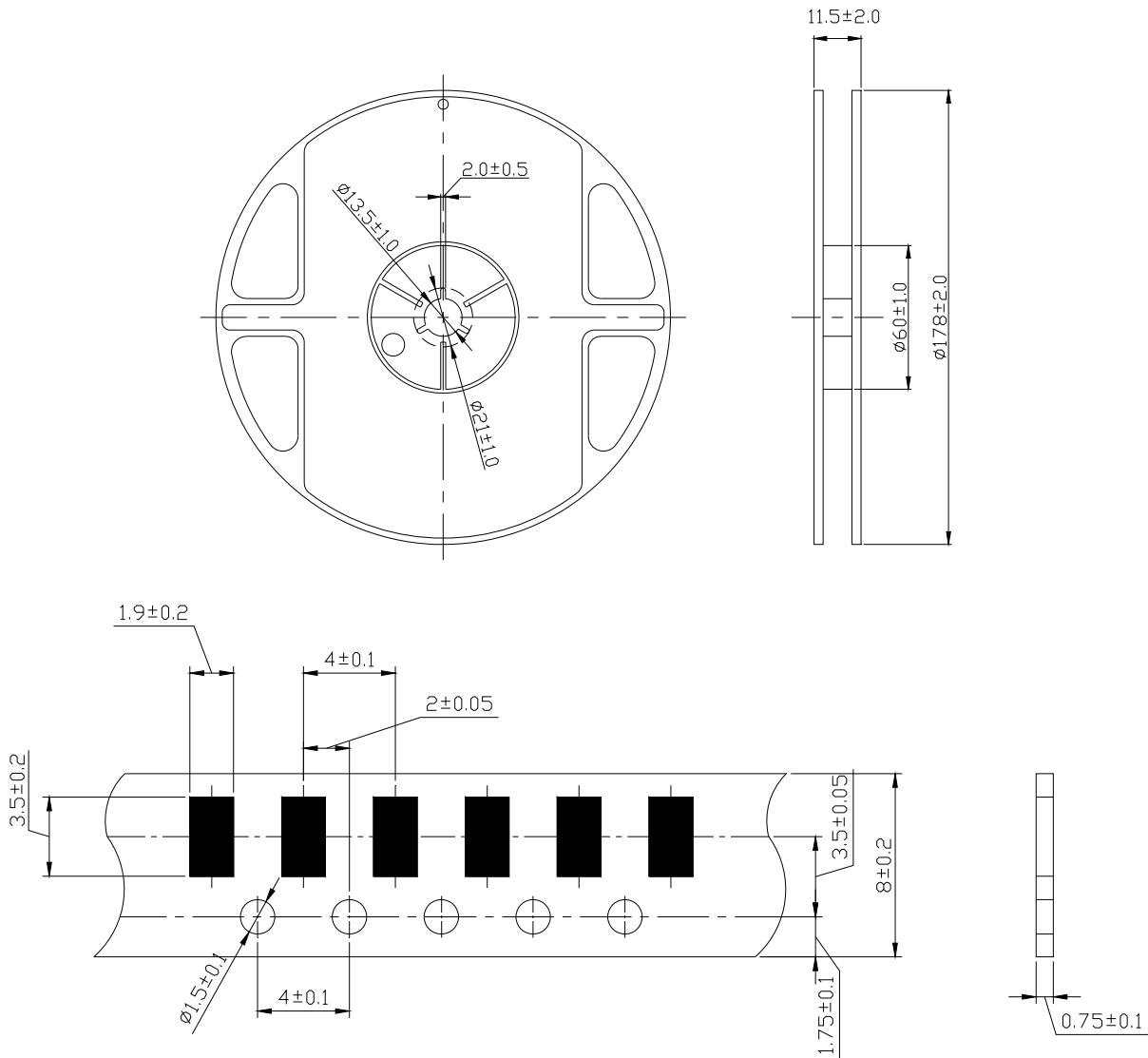

Marking direction

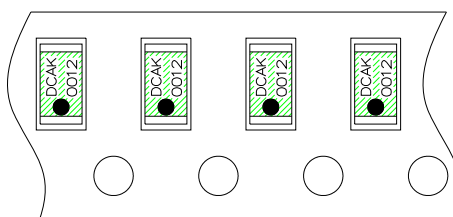

Dielectric Chip Antenna 1561~1610MHz
Part No: MP11524

Model: DCA70S01
Rev. No: 2

10. TRANSMISSION LINE AND MATCHING:

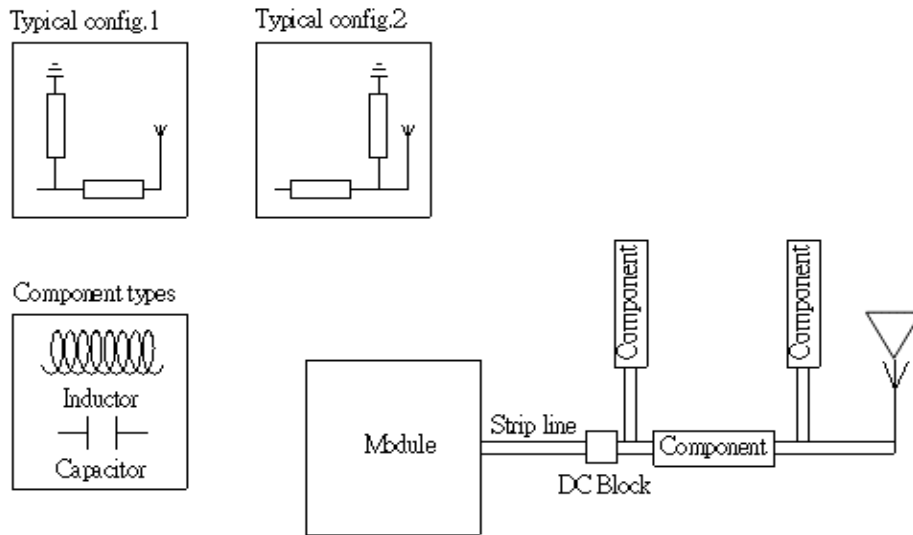

The matching network has to be individually designed using one,two or three components.

Dielectric Chip Antenna 1561~1610MHz
Part No: MP11524

Model: DCA70S01
Rev. No: 2

11. RECOMMENDED REFLOW SOLDERING PROFILE:

Cirocomm products can be assembled following Pb-free assembly. According to the Standard IPC/JEDEC J-STD-020C, the temperature profile suggested is as follow:

Phase	Profile features	Pb-Free Assembly (SnAgCu)
PREHEAT	-Temperature Min (T _{smin}) -Temperature Max (T _{smax}) -Time (t _s) form (T _{smin} to T _{smax})	150°C 200°C 60-120 seconds
RAMP-UP	Avg. Ramp-up Rate (T _{smax} to TP)	3°C/second(max)
REFLOW	-Temperature (T _L) -Total Time above T _L (t _L)	217°C 30-100 seconds
PEAK	-Temperature (TP) -Time (t _p)	260°C 5-10 second
RAMP-DOWN	Rate	6°C / second max.
Time from 25°C to Peak Temperature		8 minutes max.
Composition of solder paste		96.5Sn/3Ag/0.5Cu
Solder Paste Model		SHENMAO PF606-P26

Note: All the temperature measure point is on top surface of the component, if temperature over recommend, it will make component surface peeling or damage.

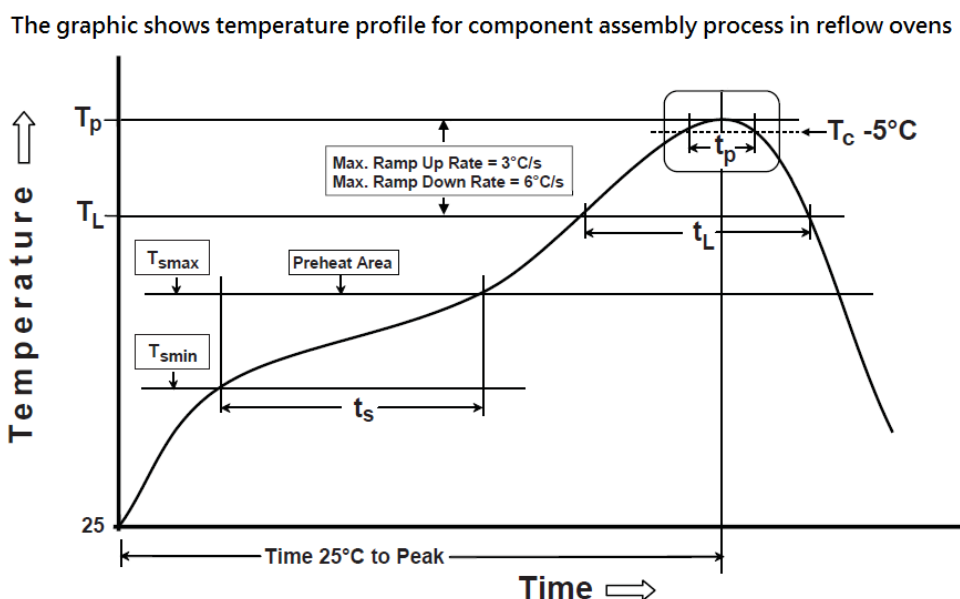

Dielectric Chip Antenna 1561~1610MHz
Part No: MP11524

Model: DCA70S01
Rev. No: 2

Soldering with iron

Soldering condition: Soldering iron temperature $270\pm 10^{\circ}\text{C}$.

Apply preheating at 120°C for 2-3 minutes. Finish soldering for each terminal within 3 seconds, if soldering iron over temperature $270\pm 10^{\circ}\text{C}$ or 3 seconds, it will make component surface peeling or damage.

Soldering iron cannot leakage of electricity.